

THE EARLY SKYMASTER STORY

In recognition of the engine-out controllability difficulties inherent in conventional twins, Cessna engineers searched for a feasible method of obtaining centerline thrust in 1959. We considered pancake engines driving a single propeller, closely-spaced side-by-side engines/propellers, and finally, the chosen push-pull engine arrangement. Our friend Bill Lear urged us to keep the airplane with a fixed landing gear – his reasoning was that only rich, middle-aged pilots can afford a twin-engine airplane, and often they are not very proficient pilots due to a lack of spare time to maintain proficiency.

Once again, Don Ahrens was asked to head up the project that would start with the C-336 and eventually become the Cessna 337, with help from the aerodynamics, power plant, structure, and electrical groups. Had we had the foresight to anticipate a retractable landing gear addition years later (in the C-337) we might have selected a lowing configuration. In hindsight, this would have made a more attractive airplane and it would have been much more adaptable to a retractable landing gear. However, it seemed natural to go with a high-wing version for the benefits of better stability, gravity flow fuel system, and shelter from the elements while enplaning and deplaning. To keep this rather top-heavy airplane as low as possible, we also dismissed the idea of a downward-sloping nose so typical of our single-engine models. This later proved unwise as the airplane appeared to cruise nose-high. In later versions the wing incidence and cowl shape were modified to improve over-the-nose visibility.

Special attention was given to crashworthiness with the rear engine's proximity to the rear seat passengers. Consequently, the rear engine mount was designed to crush downward and pivot forward with a straight-ahead impact. This principle was confirmed many years later when a C-336 lost an engine after take-off from the 7,347 foot elevation, Mexico City Airport, and with a windmilling propeller it struck a large dike in essentially level flight. Onlookers found the rear engine tilted (as designed) to a lower location with the propeller still idling. Despite the rather high true airspeed at impact, the occupants all survived and there was no penetration of the rear engine into the cabin.

To save weight and provide space for control cables to the empennage, wing struts were used between the wing boom attachment area and the lower fuselage. These extruded "H" beans were covered with removable sheet metal fairings. Auxiliary pumps were installed in the leading edge of the wing. Since high speed was not a top priority, we used a large wing area of 202 square feet and an aspect ratio of 7.2. A NACA 2412 airfoil was used at the wing root and boom, tapering to a 2409 section of the tip. The wing was fitted with powerful flaps located outboard of the twin booms. These were 30% of wing chord slotted flaps that were 8 feet in length on each side. In contrast, the Frise type ailerons were only 4.75 feet in length with a 25% chord width. This was to be an airplane capable of operating from rather small and rough grass fields.

As related in Don Ahren's SAE report No. S365 entitled "The Cessna Skymaster", which was presented in Wichita Kansas on March 8, 1963:

"The wing is of a conventional two-spar design with the front spar at 20% chord and the rear spar at 60% chord. The brace strut intersects the front spar at the boom attach point. Main fuel tanks are installed outboard of the booms (between the spars), and optional auxiliary tanks are installed inboard of the

boom. The induced high torque from tail loads is transmitted through a cell structure consisting of the two spars, a large torque rib at the root, and the auxiliary fuel tank skin assemblies. Normal wing torque loads are carried by a torque rib at the outboard end of the main fuel cell area, an immediate torque rib about midway in the fuel tank region, the torque rib at the strut intersection, and the upper and lower skins. The main fuel tanks are of metal construction and designed as two separate tanks in each wing, interconnected for both fuel flow and venting. “

As one can see, these torque-resisting cells had to be designed not only for carrying the design loads, but, also, to provide an acceptable amount of rigidity for the empennage.

Newly planned Continental IO-30-A engines rated at 210 hp for take-off at 2800 rpm and 195 hp at 2600 rpm for maximum continuous operation were to be used. However, an interim geared Continental GIO-300 engine, rated at 190 hp at 3200 rpm (2400 propeller rpm), was used in the early testing, and the slower-turning propellers were much quieter than the subsequent direct-drive engines and propellers. The final IO-360 engines were delivered to Cessna in May of 1961.

Aside from the aerodynamic design challenge, the flight test group had to figure out the best arrangement of engine controls and methods of identifying a failed engine. Unlike the conventional twin, there would be no yawing motion to show which engine had failed. After much controversy between test pilots, we selected conventional single-engine push-pull type control knobs and arranged them to agree with the vertical location of the engines. The rear engine was elevated, and thus its control knobs were placed an inch or two above the front engine control knobs. This was awkward and unpopular, but we decided to try it on the prototype. To aid in identifying a failed engine, Charlie Tanner's power plant group designed a micro switch assembly that sensed fore and aft engine motion in the rubber engine mounts. With a rearward motion (from the drag of the windmilling propeller) a red warning light would illuminate in the related propeller knob. Although the aforementioned microswitch unit multiplied the actual engine movement by a factor of six, there were still false warnings that would prompt an unwarranted engine shut-down. Thus the system was removed in favor of pilot reference to engine and EGT gauge indications of power failure. Fortunately, centerline thrust (CLT) gave the pilot lots of time to study these gauges and make the proper choice. Also, the owner's manual instructed the pilot to verify his decision by momentarily reducing the throttle setting on the suspected engine to hear no audible reduction in power.

The fuel system was fairly conventional with the main 46.5-gallon (93 gallons total) fuel tanks located outboard of the wing booms. Optional 19-gallon (38 gallons total) tanks were placed in each inboard wing panel. Dual fuel selector valves (including cross feed positions) were located in an overhead console aft of the windshield.

Perhaps the biggest challenge was cooling the “buried” rear engine. Initially, rear engine cooling air was obtained by a controllable flap or scoop located in the trailing edge of the wing. It was installed between the boom and the fuselage and was the main reason why inboard flaps were not at first incorporated. The requirement for inboard flaps meant a relocation of this air entry point. Pressure surveys and tuft studies showed that the boundary layer was very thin and that high-pressure recoveries could be obtained in the area of the junction of the wing and fuselage. A scoop was installed with

a throat area of approximately 6 by 7 inches on each side of the fuselage and wing junction region, and proved quite satisfactory. We started with augments tubes in hopes that the flow through the exhaust nozzles would induce enough cooling air through the tubes. However, the length of these augmenters was restricted by the length of the cowl itself and the location of the propeller. The resulting installation requires a rather difficult air flow path. Tests revealed that by installing a large opening in the aft portion of the cowl, the combination of normal ram recovery and pumping action of the propeller (in place of the augments tubes) could be adequate to cool the engine. However, further testing indicated the presence of an undesirable character in the sound within the cabin, due to propeller blade passage by the rear cowl opening. By extending the rear propeller hub 4.5 inches and reshaping the rear cowling to approach the shape of a body or revolution, considerable improvement was realized. Cooling of the rear engine was then accomplished by the use of a moveable scoop located on top of the cowl, together with a fan attached to the crankshaft and located in the rear circular opening of the cowling. This fan was designed under the direction of our helicopter chief engineer, Charlie Seibel. It uses 20 blades with a pitch angle of 25 degrees at the tip. Since it is attached to the crankshaft, it operates at engine speed and absorbs about 3 hp at full rpm. The fan has its optimum performance during single-engine operation with the scoop door open. The entire system results were highly satisfactory during all phases of single or twin-engine operation.

As we prepare for the first flight, everyone was taking bets on which engine would give the best engine-out climb. Dave Bierman, chief engineer at Hartzell Propeller Company (and former longtime aerodynamics research engineer at NACA) put his money on the rear engine. He explained "The rear engine propeller has no blockage behind it, its diameter is two inches greater, its inflow velocity is favorably reduced, and it promotes better airflow attachment to the bluff afterbody of the rear cowl" as illustrated in figure 1. Later he proved to be right and collected the doubters' money! Test results showed the rear engine to have a 24% rate-of-climb advantage over the front engine only operation.

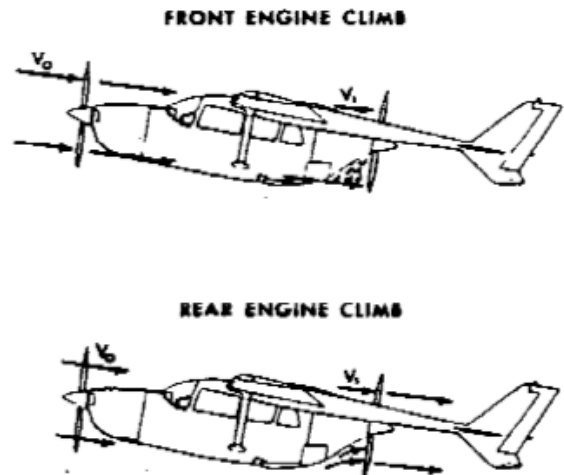

Fig. 1 — Propeller inflow and slipstream effects in single-engine climb

The author performed some fast taxi runs on the 10,000-foot runway at the adjacent McConnell AFB on February 27, 1961. I soon discovered the adverse effects of friction on both the elevator control system and the throttles. Adding to this was the extremely awkward positioning of the throttle knobs and the resulting inability to make an inadvertent lift-off to about 5-feet of altitude, and the porpoising motion that ensued are still memorable. After 1,000 feet of jockeying the elevator control and power (mostly out of phase) the airplane finally touched down to a reasonably smooth landing. I would have been much better off to have climbed initially to 5,000 feet altitude to assess those friction effects! In fact, I later advised Lockheed test pilot Leo Sullivan to do just that instead of his planned fast taxi tests with the huge C-5A prototype at Marietta, Georgia.

The actual C-336 maiden flight on February 28, 1961 was anticlimactic after that hair raising fast taxi lift off. Excerpts from the author's flight report were:

1. Take off acceleration was rather spectacular and both engines oversped momentarily to 3800 and 3900 rpm respectively. Fuel pressure readings were low on the no. 1 engine by comparison to the no. 2 engine.
2. Controllability in the climb and traffic pattern circuit was very good. The only problems were synchronizing the engines rpm's and manifold pressure since the flight test types of engine gauges are inherently difficult to interpret.
3. Longitudinal stability appeared to be slightly weak in climb and cruise configuration, partially due to the high friction in the elevator system.
4. Power off stalls at 24% MAC showed a lack of elevator effectiveness in the flaps up condition and complete stalls were obtainable on only 20 and 30-degree flap positions. Pitching moments were very severe with 40-degree flaps, preventing the airplane from slowing down below 110 mph.
5. A check of airplane pitch with a windmilling aft propeller showed no visible effects. However, pulling back the front engine to idle rpm gave the customary nose-down pitch as we have on our single-engine airplanes.
6. Landing approach was made with 15-degree flaps and the airplane decelerated rather slowly in the flare-out. Touchdown was made in a slightly tail-low position with good control.
7. In general, the airplane is much better than expected in vibration, visibility, and seating comfort. Stability and control were about what we expected; that is slightly marginal on elevator power and longitudinal stability. It is believed that all of the problems encountered can be worked out readily in the development stage.

We suffered with the friction problems while the C-336 engineers designed a replacement of the round-robin cable routing for the elevator in the form of driving that control from "one boom" cable routing. This later removed seven pulleys of the cable cross-over system and eliminated most of the objectionable friction.

The twin rudder control system is routed completely around the aircraft, with one cable going down the left boom and the second down the right boom. A cross-over cable through the horizontal stabilizer completes the system. Elevator tab cables are installed through the right wing strut and down the right boom.

The unacceptable engine control arrangement was redesigned to use a C-310 style placement of side-by-side throttle, propeller, and mixture control levers. Now the pilot had to relate the left lever to the front and the right lever to the rear engine. If one

visualized the front engine as his primary engine it seemed reasonable to assume that the left lever was a primary lever.

In the meantime we explored the flight characteristics of this rather unconventional airplane and quickly found some inadequacies. These included deficiencies in elevator power, longitudinal trim power, and vertical tail area. The large flaps created strong nose-down pitching motions that could not be fully trimmed out in a glide. Unlike conventional airplanes, there was no flap-induced downwash over the horizontal tail to give a compensating pitch-up motion to the airplane. Thus we had to bite the bullet by adding flaps between the fuselage and the booms. They reduced the flaps down trim change felt by the pilot by 65%. In addition, they reduced the minimum speed at forward C. G. by 9 mph and permitted an additional 6% MAC forward extension of the C. G. envelope. Our initial misgivings concerning inboard flaps were not justified because they have had no adverse affects on the inflow to the rear propeller. Elevator effectiveness was increased by adding more area in a more "constant energy" location at each extremity. Minimizing those elevator cut-out areas was obtained by restricting the rudder travel to only 15 degrees inboard while retaining the original 21 degrees outboard deflections.

To further enhance longitudinal trim power, we reduced the maximum flap setting from 40 to 30 degrees except that the inboard flaps retained the greater setting. Finally, we lengthened the elevator trim tab span to provide more trim capability. One particular problem surrounding longitudinal trim power requirements was associated with power-off, power on changes, particularly as the elevator was operating in the high energy. A variety of elevator tab spans and chores were tested in an attempt to reduce the high stick forces. Shorter spans, while reducing stick forces, drastically reduced the ability to trim power-off. A promising solution would be that resulting in rapid trim changes at high tab angles. A differential bell crank in the tab control mechanism was the answer. This permitted rapid motion at high tab settings and relatively slow motion near the neutral setting. In other words, the tab control is very sensitive at high deflections and very insensitive during the cruise settings.

We also looked for an interconnect system that would automatically change the trim tab setting as the flaps were extended and retracted electrically. Bill Seidel, assistant project engineer, designed a clever device that "semi-automatically" reduced very heavy out-of-trim elevator forces in balked landing climb-outs when the flaps were retracted as illustrated in Figure 2. The progression of elevator stick force changed from a landing configuration glide to a balked-landing-climb and, finally, to a flaps-retracted climb is illustrated graphically in Figure 3. As power is applied, the nose-up trim must be counteracted by a 40-pound push force. Then as flaps are retracted (removing a powerful nose-down pitching moment) an additional push force up to 80-pound is required to maintain the original trim speed. This test increment of push force was eliminated very neatly by Bill's invention. The elevator trim tab cables are routed down the right tail boom. A

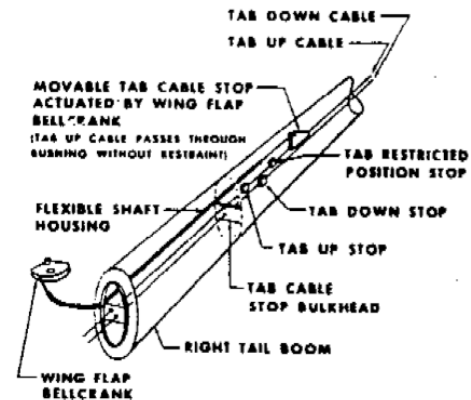

Fig. 2.- Elevator trim/wing flap interconnect system

flexible shaft connects to one arm of the wing flap bellcrank and engages a swaged ball on the tab cable during part of its travel. With flaps retracted, the pilot can trim the elevator tab to no more than 10 degrees with flaps extended, the flexible shaft moves aft, permitting additional manual adjustment of the tab to 26 degrees. Conversely, when the flaps are retracted electrically from 30 to 15 degrees, the flexible shaft automatically drags the tab cable from the original position to 10 degrees. This relieves the out of trim force to 20-pounds as shown in the aforementioned graph. In addition, it relieves the pilot from manually making large trim wheel rotations during this period of high activity by the pilot.

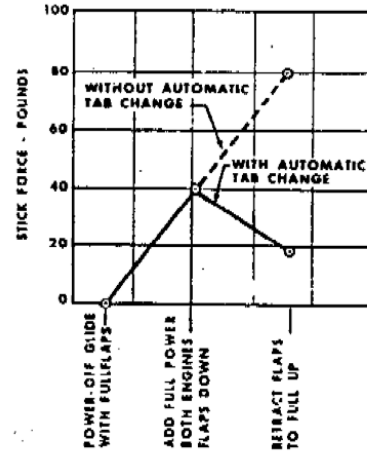

Fig. 3 - Longitudinal trim changes in bailed landing go-around

Slipstream effects or, more accurately, “the reinforced” slipstream in this tandem-twin suggested no overhanging aerodynamic balance area that would be vulnerable to varying slipstream velocities. This omission would cause rather heavy elevator forces in the landing. The addition of an elevator down spring for cruising stability would increase landing stick forces still further. Therefore, it was necessary to design a unique downspring optimized for good cruising stability, and which went out of action with large up-elevator deflections in the landing flare. Subsequently, an “overcenter” spring was adopted to reduce those stick forces. This proved to be a good solution to accommodate slip stream velocities ranging from 50% of free stream velocity (propellers idling) to as much as 250% at full throttle at 74 mph (or an increase by a factor of 3).

Directional stability was adequate in all normal flight conditions. However, in the bailed-landing climb (full flaps and 75% power) when releasing the rudder pedal force from full-rudder skids, the rudder did not return to center. Therefore, it was necessary to increase the vertical tail area (in steps) by 25% and eventually, by 40%. These changes also reduced the adverse yaw in turns. As they were incorporated in August of 1961, R. L. “Dick” Kemper had taken over the project test pilot duties, and he continued the task of recommending further refinements to the prototype. He verified the excellent stall characteristics (better than any conventional twin). Dick also conducted a spin program since the gross weight at that time was less than 4,000 pounds. He reported excellent spin characteristics with a desirable steeply nose-down spin attitude and prompt recoveries within 1/2 turn with opposite rudder to slow the rotation and brisk forward pressure to break the spin. He noted that the elevator is the predominant recovery control, and it should be applied briskly and positively for best recovery. By December 1961 the prototype was updated and ready for the final type certification testing. The type certificate was granted on May 22, 1962. Despite the unconventional design and the absence of a wind tunnel program, the following table illustrates the remarkable pace of progress in this Skymaster development:

January 1960	Skymaster configuration approved
April 1960	First engineering prototype started
July 1960	Full-scale mock-up complete
February 28, 1961	First engineering prototype maiden flight

March 14, 1962	Second engineering prototype maiden flight
May 22, 1962	FAA Type Certificate
August 1962	Pre-production prototype flown
November 1962	First production airplane
May 1963	First dealer demonstrator delivery

With the absence of interior soundproofing and upholstery, the prototype's noise level was deadening. Our acoustics engineer, George Altner, had his work cut out for him in developing a better muffler (in place of the noisy augments tubes) and the most efficient sound proofing methods. The presence of two engines, one at each end of the passenger compartment, created noise sources that had to be controlled. A variety of methods were tested including three bladed propeller, rear propeller shaft extensions, and acoustical baffles in the rear engine compartment. The rear engine mount, designed for crashworthiness, was more flexible than desired for vibration isolation. The rigid requirements of weight, cost, C.G. control, and detail design criteria presented a difficult obstacle for George. From his experience in the C-310 program, he launched a noise and vibration reduction effort that seemed overwhelming. He used sophisticated B & K decibel meters and vibration measuring devices that produced amplitude vs. frequency read outs on tapes. From these read outs we could pinpoint the source of particular noises or vibrations such as propeller, engine, wind noise, etc. Many combinations of sound deadeners, shock mounts (engine and front cowling), and acoustical baffles were tested and/or adopted. However, this was to be a continuous program which never silenced the airplane to our single engine airplane standards. The external noise level was also very distinctive, making the Skymaster readily identifiable when heard from below.

An extensive static load test was performed with the tail booms, vertical tails, and horizontal tail tested as an assembled unit. The resulting bent (difficult to calculate moment distribution simply) presented a structural problem in the vertical tails as a result of side load condition. The transition from a high rigidity in the horizontal tail to a comparatively low rigidity in the booms created a design problem. The incorporation of an external stiffener, similar in appearance to a strake, was the solution that provided adequate moment distribution.

In addition, an extensive fatigue program was conducted on such areas as landing gears and attachments, wing struts and attachments, engine muffler, and door mechanisms. A complete program of impact testing was conducted by installing a static test fuselage in a large pendulum. Mass was distributed, as required, throughout the fuselage. The entire assembly was raised at varying heights and was then released to crash into a barrier in order to determine the impact resistance of the main landing gear and nose gear. Complete impact testing on the rear engine was also conducted. In this case, the engine mount design proved itself. Under horizontal impact testing, the engine mount structure collapsed in a downward arc, thus protecting the passengers from a directly forward moving mass.

Performance and specifications for the C-336 as presented in the owner's manual are shown below:

Gross Weight	3,900 lbs
--------------	-----------

Speeds, Best Power Mixture:	
Top Speed	183 mph
Cruise, 75% power at 7,000 ft	173 mph
Range, Normal Lean Mixture:	
Cruise, 75% Power at 7,000 ft	745 mi
92 Gallons, No Reserve	4.3 hrs
	172 mph
Cruise, 75% Power at 7,000 ft	1,040 mi
128 Gallons, No Reserve	6.0 hrs
	172 mph
Optimum Range at 10,000 ft	945 mi
92 Gallons, No Reserve	7.7 hrs
	123 mph
Optimum Range at 10,000 ft	1,315 mi
128 Gallons, No Reserve	10.7 hrs
	123 mph
Rate of Climb at Sea Level:	
Twin Engine	1,340 fpm
Front Engine Only	355 fpm
Rear Engine Only	420 fpm
Service Ceiling:	
Twin Engine	19,000 ft
Front Engine Only	8,200 ft
Rear Engine Only	9,500 ft
Absolute Ceiling:	
Twin Engine	20,400 ft
Front Engine Only	9,500 ft
Rear Engine Only	10,800 ft
Take-Off:	
Ground Run	625 ft
Total Distance Over 50 ft Obstacle	1,145 ft
Landing:	
Landing Roll	655 ft
Total Distance Over 50 ft Obstacle	1,395 ft
Stall Speed: Flaps down, Power Off	60 mph
Empty Weight (approximate)	2,320 lbs
Baggage Allowance	365 lbs
Wing Loading: pounds/sq ft	19.4 lbs
Power Loading: Pounds/HP	9.3 lbs
Fuel Capacity: total	
Standard Tanks	93 gal
Optional Auxiliary Tanks	131 gal
Oil Capacity: total	5 gal
Propellers:	
Constant Speed, Full Feathering, Diameter	76 in
Power:	
Two Continental Fuel Injection Engines	IO-360-A
210 rated HP at 2800 RPM (take-off)	
195 rated HP at 26.5" MP and 2800 RPM	
(Maximum Continuous)	

The aviation industry considered the C-336 to be a landmark airplane from a safety standpoint. The editor of Air Facts Magazine, Leighton Collins (a great promoter of aviation safety), asked for a unique demonstration. He wanted to be a passenger on a flight to the nearby long runway at Strother Field. Then he wanted to take the pilot seat and make his first flight using only the rear engine.

Thus he would act as a single-engine pilot flying a twin on only one engine. We worked that plan, and he was delighted to take in flight pictures of that stationary propeller in front of him for a subsequent magazine article with a side bar stating "The newest thing in thirty years". Like all of us, he thought that we had a winner in this revolutionary airplane.

In 1963 the author prepared a Society of Automotive Engineers paper no. 781D entitled "Centerline Thrust For Twin Engine Aircraft" and presented it in Detroit, Michigan on January 17, 1964. This paper focused on the controllability and engine out advantages in CLT airplanes.

Sketches of the thrust/drag vectors with an engine out are shown in Figure 4 with comparative take off profiles and graphical comparisons of total take-off distances in Figures 5 through 8. The flight path shown by the solid line in Figure 5 indicates the normal twin-engine climb-out path, and the dotted lines represent (schematically) two possible flight paths with an engine failure.

In the speed range marked "area of decision" the pilot chores are compared in the following paragraphs:

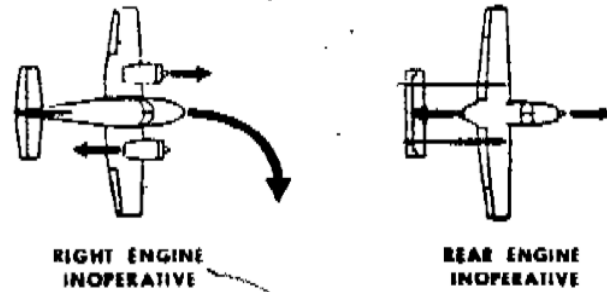

Fig. 4 - Effect of engine failure on directional control

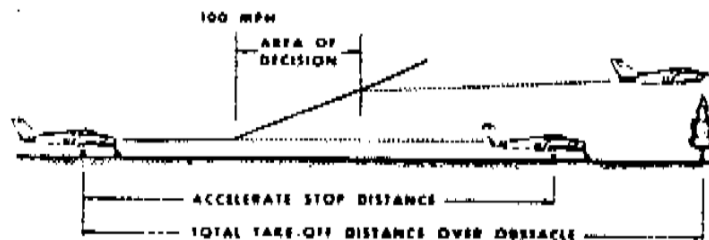

Fig. 5 - Single engine take-off - conventional twin

1. The conventional twin will yaw sharply in the direction of the failed engine, and if the speed is below V_{mc} it will also roll in that direction.
2. Counteract yaw and roll with full opposite rudder and partial opposite aileron while maintaining at least V_{mc} speed and a constant heading.
3. Decide whether to terminate or continue the take off. Assuming that the take off is to be continued, retract the landing gear.
4. Identify the failed engine, remembering that "idle foot identifies idle engine".
5. Feather the windmilling propeller.
6. Trim the rudder tab to counteract asymmetric thrust.
7. Accelerate to V_y climb speed (or V_x speed with obstructions ahead).
8. Climb over any obstructions at the end of the field.

- Maneuver around obstructions while circling the field for an emergency landing.

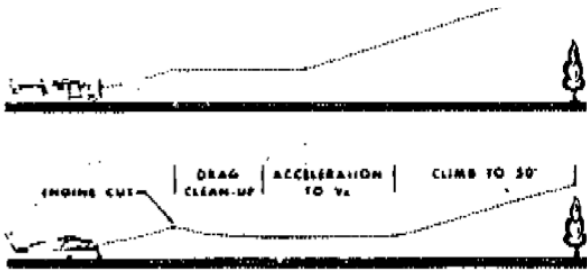

Fig. 6 - Take-off profile with engine cut at $1.2 V_s$

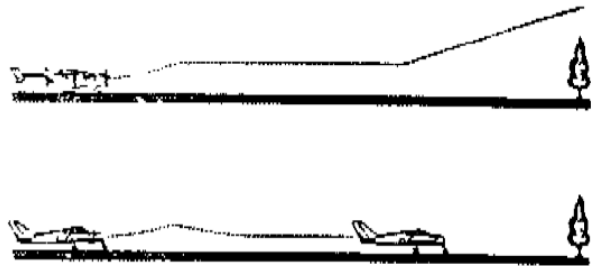

Fig. 7 - Take-off profile with engine cut at $1.1 V_s$

All of the foregoing chores must be accomplished in moments of great excitement (if not panic), and any mismanagement of these procedures can result in either a loss of control or a serious loss of performance.

The CLT twin in this same situation requires no special technique or proficiency other than:

- Ascertaining that the airplane has reached a minimum safe single engine climb speed.
- Cleaning up the airplane (landing gear retraction and propeller feathering).
- Accelerating to a suitable climb speed.
- Climbing over the obstacle.

In this case, the most serious penalty for mismanagement would be the inability to climb over the obstacle. Consequently, every take-off in a CLT twin requires no more "pre-take-off" preparation than in a single engine airplane.

In comparing the last two take-off profiles, one can see that the CLT twin's engine-out take-off distance advantage is amplified as the airspeed at engine cut is reduced from $1.2 V_s$ to $1.1 V_s$ in this case the conventional twin has no alternative but to discontinue the take-off because the engine cut occurs at an airspeed lower than minimum control speed (V_{mc}). In contrast, the CLT airplane is able to continue with the take-off since its V_x speed is very close to the $1.1 V_s$ speed. These comparisons are illustrated convincingly in Figure 8, showing numerical distances as a function of engine-out speed.

Despite these enormous safety advantages, the C-336 was not a success in the market place. Potential customers disagreed with Bill Lear's prophecy that high speed was not important. Many pilots ridiculed the safety features, implying that they are

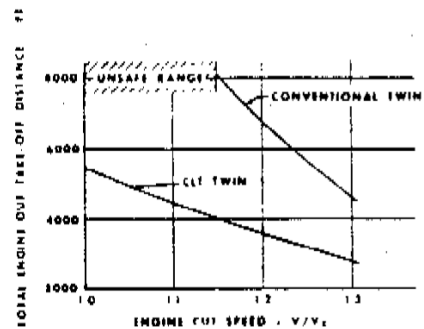

Fig. 8 - Effect of engine cut speed on total take-off distance over 50 ft obstacle

macho pilots capable of handling engine-out emergencies in conventional twins. The rather staid appearance of the airplane could not compare with the sleek lines of the C-310 and other twins of that era, and this was a drawback. And, finally, to our great disappointment, the safety record of the C-336 was not very impressive. We learned that in very hot weather the rear engine would occasionally die while taxiing out for take-off. All too frequently, the pilot would be unaware of this loss, and, skipping the pre-take-off engine run-ups, he would inadvertently take-off on the front engine only. Several bad crashes occurred in this situation. We were obliged to revise the owner's manual instructions to request, "advancing the rear engine power first to insure its operation". Another problem was the temptation to show off the engine-out flying qualities to friends over high-elevation territory, and then have difficulties in restarting the engine as the airplane slowly descended on one engine. And, of course, the airplane had more than a normal share of "low-proficiency" pilots to add to these woes.

In reflection of these problems, deliveries of the C-336 were only 197 units of the 1963 - 64 model years at a price of \$39,950.00. To the FAA's credit, however, they later developed a simple "centerline thrust" rating for pilots flying the C-336 and C-337, in late 1991 the author was asked to ferry a beautifully maintained C-336 a short distance. While refreshing my memories of its stall characteristics, I was amazed at the gentle stall behavior and the low stall speed. The same was true in the subsequent landing flare and touchdown. My only embarrassment was forgetting that the fuel selector valves were located up in the ceiling instead of on the cabin floor or sidewalls!

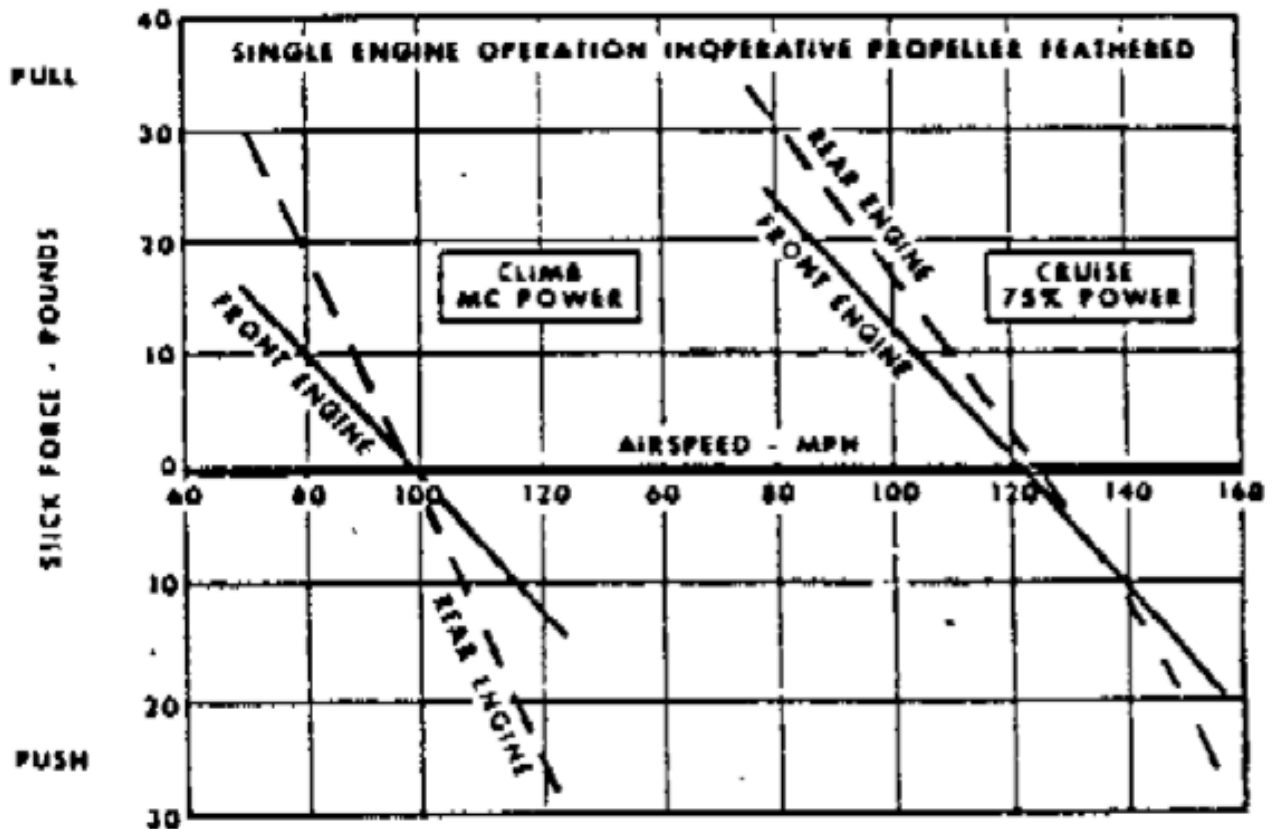

FIG. 9

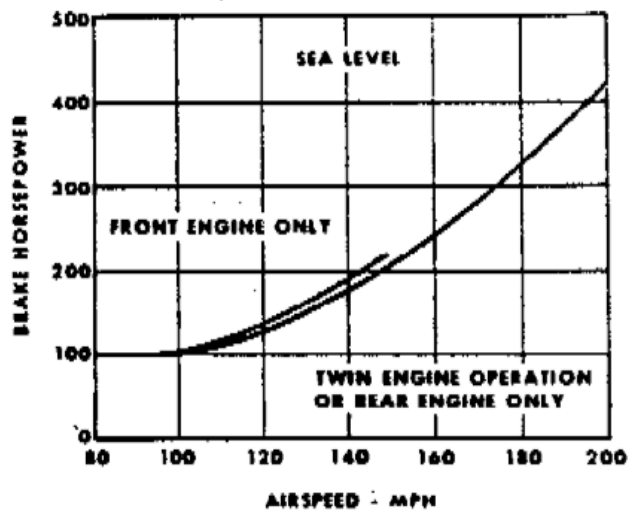

Fig. 10 - Effect of front or rear engine operation on speed-power

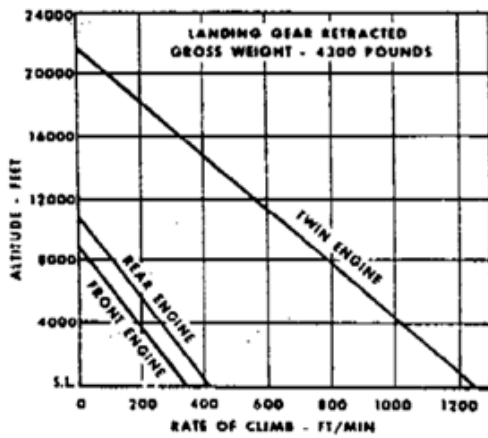

Fig. 11 - Rate of climb versus altitude

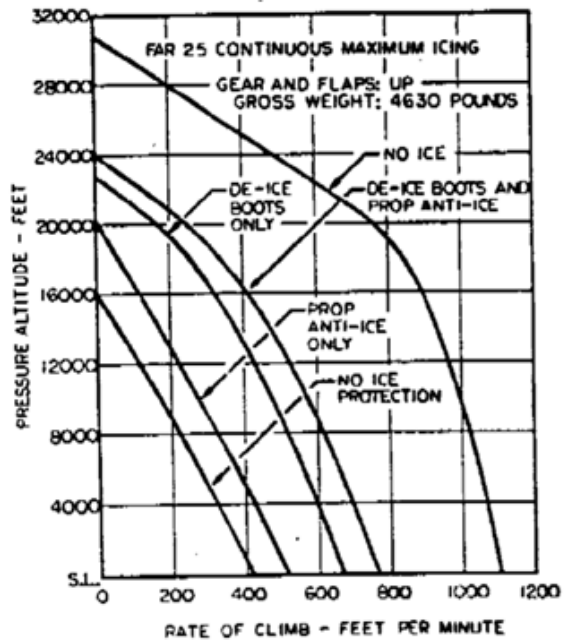

Fig. 12 - Icing climb performance decrements for Super Skyman